



DONGGUAN NANJING ELECTRONICS LTD.,
TO-92 Plastic-Encapsulate Transistors

BC635 / BC637 / BC639 TRANSISTOR (NPN)

FEATURES

- High current transistors

MARKING

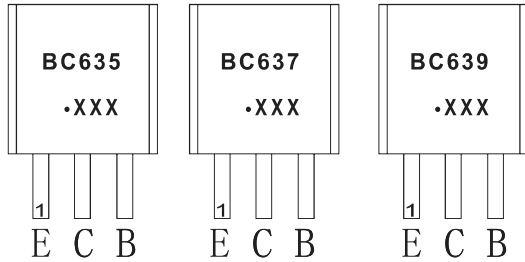

BC635,BC637,BC639=Device code

Solid dot=Green molding compound device,
if none,the normal device

XXX=Code

ORDERING INFORMATION

Part Number	Package	Packing Method	Pack Quantity
BC635	TO-92	Bulk	1000pcs/Bag
BC635-TA	TO-92	Tape	2000pcs/Box
BC637	TO-92	Bulk	1000pcs/Bag
BC637-TA	TO-92	Tape	2000pcs/Box
BC639	TO-92	Bulk	1000pcs/Bag
BC639-TA	TO-92	Tape	2000pcs/Box

MAXIMUM RATINGS (T_a=25°C unless otherwise noted)

Symbol	Parameter	Value	Unit
V _{CB0}	Collector-Emitter Voltage	BC635	45
		BC637	60
		BC639	100
V _{CE0}	Collector-Emitter Voltage	BC635	45
		BC637	60
		BC639	80
V _{EB0}	Emitter-Base Voltage	5	V
I _c	Collector Current -Continuous	1	A
P _c	Collector Power Dissipation	0.83	W
T _J	Junction Temperature	150	°C
T _{stg}	Storage Temperature	-65-150	°C

TO-92

1. EMITTER
2. COLLECTOR
3. BASE

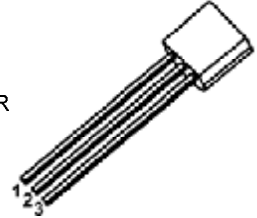

Equivalent Circuit

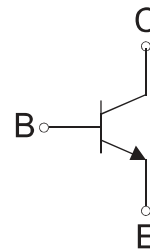

ELECTRICAL CHARACTERISTICS

$T_a=25\text{ }^\circ\text{C}$ unless otherwise specified

Parameter	Symbol	Test conditions	Min	Typ	Max	Unit
Collector-emitter breakdown voltage	$V_{(BR)CEO}$	$I_C=10\text{mA}$, $I_B=0$ BC635	45			V
		BC637	60			V
		BC639	80			V
Collector cut-off current	I_{CBO}	$V_{CB}=30\text{V}$, $I_E=0$			0.1	μA
Emitter cut-off current	I_{EBO}	$V_{EB}=5\text{V}$, $I_B=0$			0.1	μA
DC current gain	$h_{FE(1)}$	$V_{CE}=2\text{V}$, $I_C=5\text{mA}$	25			
	$h_{FE(2)}$	$V_{CE}=2\text{V}$, $I_C=150\text{mA}$ BC635	40		250	
		BC637-10/BC639-10	63		160	
		BC637-16/BC639-16	100		250	
	$h_{FE(3)}$	$V_{CE}=2\text{V}$, $I_C=500\text{mA}$	25			
Collector-emitter saturation voltage	$V_{CE(sat)}$	$I_C=500\text{mA}$, $I_B=50\text{mA}$			0.5	V
Base-emitter voltage	V_{BE}	$V_{CE}=2\text{V}$, $I_C=500\text{mA}$			1	V
Transition frequency	f_T	$V_{CE}=5\text{V}$, $I_C=10\text{mA}$, $f=50\text{MHz}$		100		MHz

Typical Characteristics

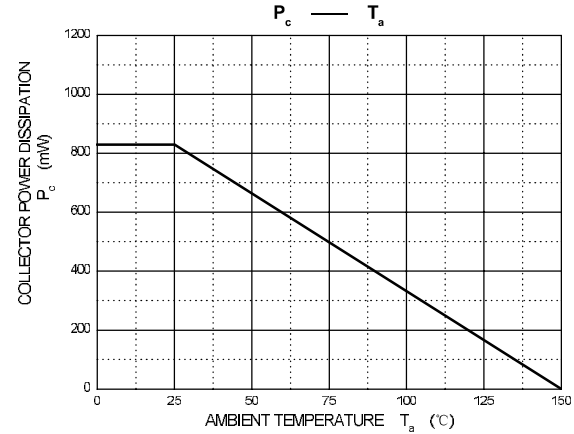
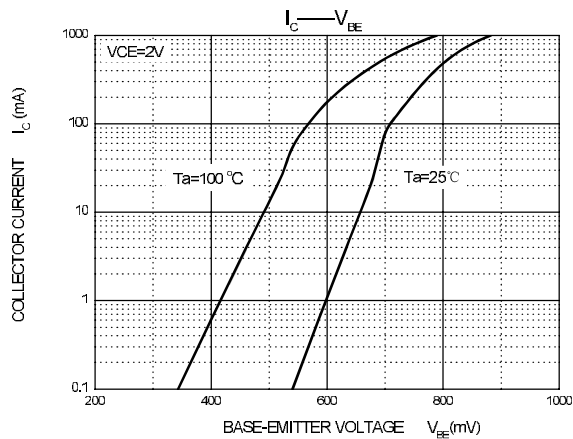
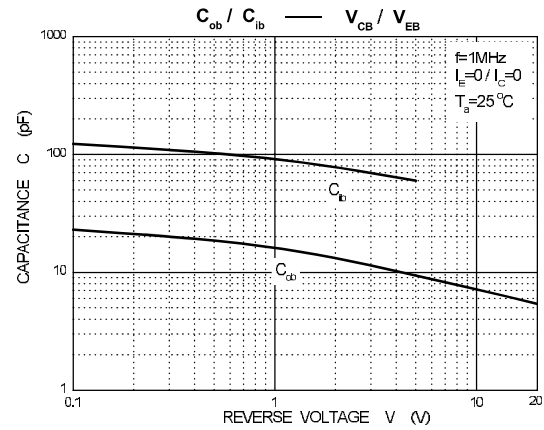
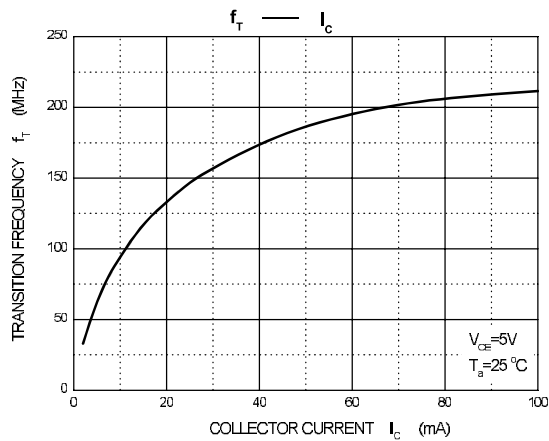
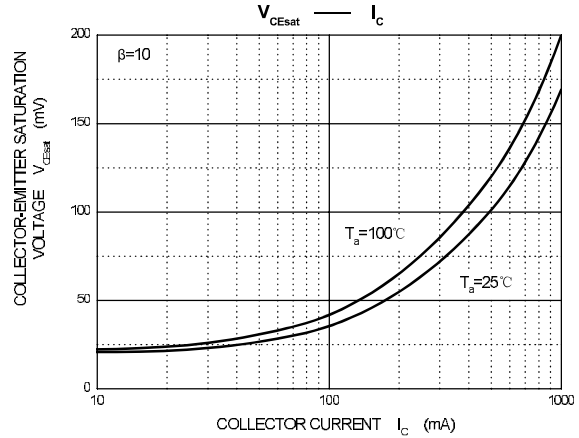
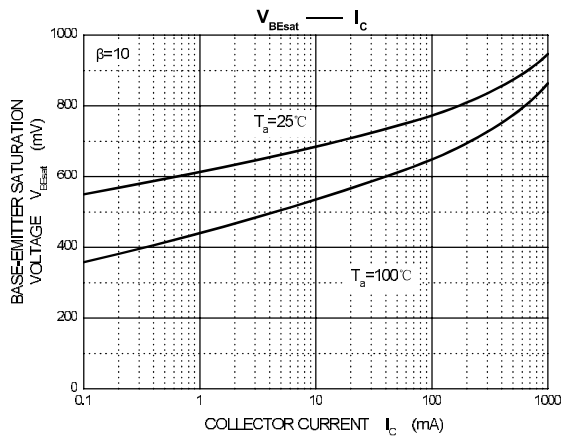
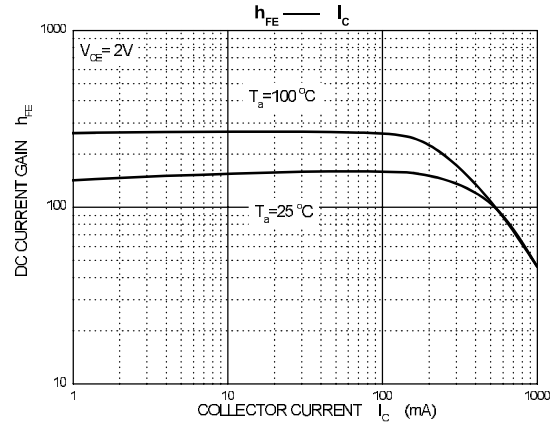
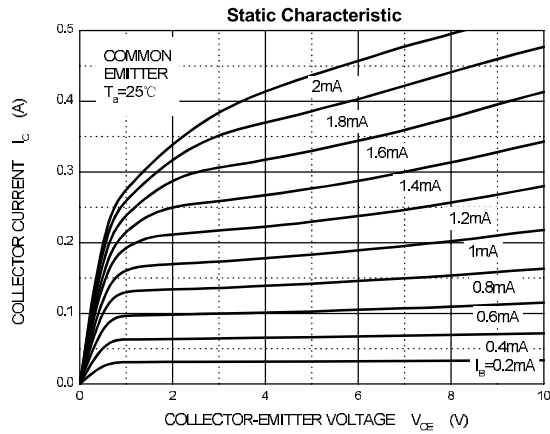

TO-92 Package Outline Dimensions

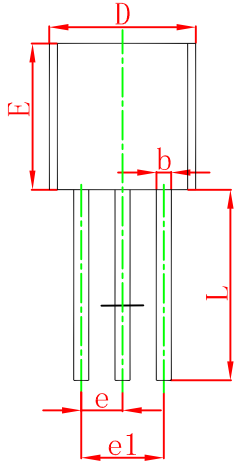
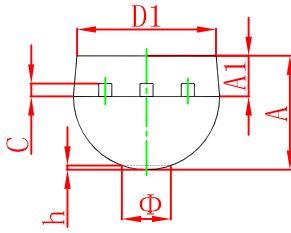

Symbol	Dimensions In Millimeters		Dimensions In Inches	
	Min	Max	Min	Max
A	3.300	3.700	0.130	0.146
A1	1.100	1.400	0.043	0.055
b	0.380	0.550	0.015	0.022
c	0.360	0.510	0.014	0.020
D	4.300	4.700	0.169	0.185
D1	3.430		0.135	
E	4.300	4.700	0.169	0.185
e	1.270 TYP		0.050 TYP	
e1	2.440	2.640	0.096	0.104
L	14.100	14.500	0.555	0.571
Φ		1.600		0.063
h	0.000	0.380	0.000	0.015

TO-92 Suggested Pad Layout

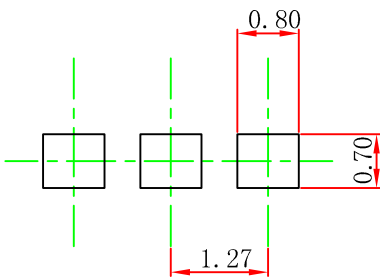

Note:

1. Controlling dimension: in millimeters.
2. General tolerance: $\pm 0.05\text{mm}$.
3. The pad layout is for reference purposes only.

TO-92 PACKAGE TAPEING DIMENSION

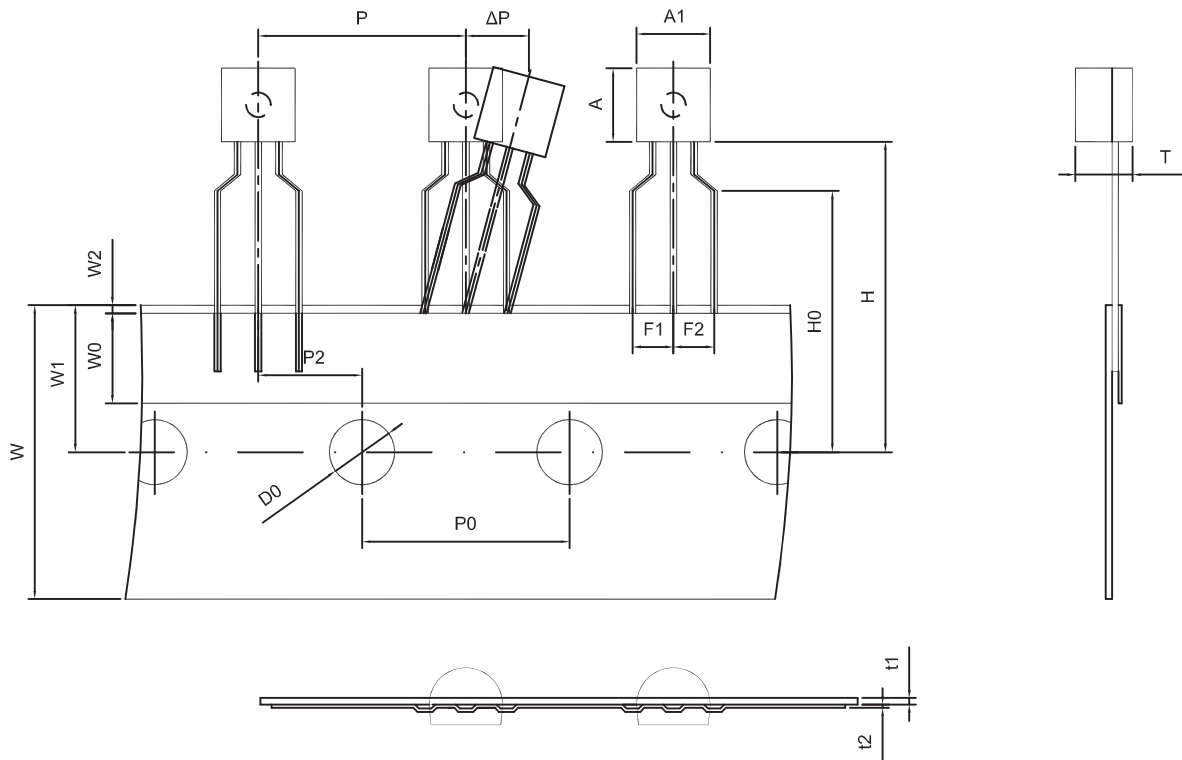

Dimiensions are in millimeter

A1	A	T	P	P0	P2	F1	F2	W
4.5	4.5	3.5	12.7	12.7	6.35	2.5	2.5	18.0
W0	W1	W2	H	H0	D0	t1	t2	ΔP
6.0	9.0	1.0 MAX.	19.0	16.0	4.0	0.4	0.2	0

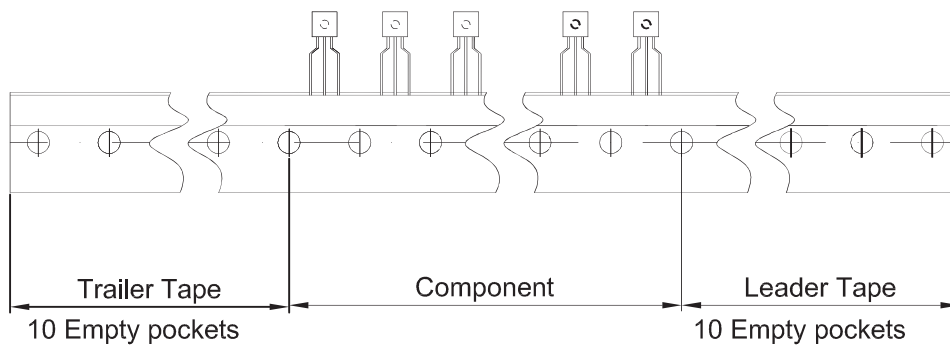

Package	Box	Box Size(mm)	Carton	Carton Size(mm)
TO-92	2000 pcs	333×162×43	20,000 pcs	350×340×250